

THESE ARE THE MANUFACTURER'S APPLICATION INSTRUCTIONS FOR THE ROOFING CONDITIONS DESCRIBED. TAMKO BUILDING PRODUCTS, INC. ASSUMES NO RESPONSIBILITY FOR LEAKS OR OTHER ROOFING DEFECTS RESULTING FROM FAILURE TO FOLLOW THE MANUFACTURER'S INSTRUCTIONS. THIS PRODUCT IS COVERED BY A 50 YEAR LIMITED WARRANTY. TO OBTAIN A COPY OF THE WARRANTY CALL 800-641-4691 OR VISIT OUR WEBSITE AT metalworksroof.com or tamko.com. WE RECOMMEND YOU CONSULT A PROFESSIONAL ROOFING CONTRACTOR FOR INSTALLATION OF YOUR TAMKO METALWORKS ROOF.

PREPARATION & BASIC REQUIREMENTS FOR THE METAL SHINGLE ROOFING SYSTEM

- METALWORKS shingles are for application to roof decks with slopes of at least 3 inches per foot and up to vertical application. For slopes between 3 and 4 inches per foot, TW Metal & Tile Underlayment or TW Underlayment must be used over entire deck area for new roof construction. Refer to page 5 "UL Class A Fire Rated Roof" for more information.
- Fasteners are to be 11 or 12 gauge galvanized steel with 3/8" (1cm) heads. Stainless Steel nails and other stainless steel fasteners should **not** be used with this product. The minimum length of fastener is 1 1/2" (3.8cm). Fasteners must penetrate the deck by at least 1/2" (1.3cm). Check Local Building Codes for maximum allowable roof layers.
- TAMKO recommends all field formed flashing be formed from METALWORKS Trim Coil.
- Sealant shall be one part urethane contractor grade sealant.

Care for the Material

- Boxes should be kept in a dry place and under opaque tarps while on the site.
- Use care when stacking boxes, For shingle boxes the maximum stacking level is three high. Do not stack pallets over two high.
- Boxes should be stacked on their sides. Do not lay boxes flat. Boxes are marked with arrows indicating the proper stacking direction.
- Avoid having loose materials on the roof.

Sheathing

NEW ROOF DECK CONSTRUCTION: Roof deck must be smooth, dry and free from warped surfaces.

REROOFING: Before reroofing it is recommended that old metal drip edges be removed at eaves and rakes.

PLYWOOD: All plywood shall be exterior grade as defined by the Engineered Wood Association. Plywood shall be a minimum of 3/8" thickness and applied in accordance with the recommendations of the Engineered Wood Association.

Ventilation

VENTILATION: Inadequate ventilation of attic spaces can cause accumulation of moisture in winter months and a build up of heat in the summer. These conditions can lead to:

- Vapor Condensation
- Deterioration of insulation, wood and other construction materials
- Mold and mildew
- Ice damming on the roof

To help ensure adequate ventilation and circulation of air, place

Ventilation (continued)

louvers of sufficient size high in the gable ends and install an adequate number of roof vents and soffit vents. FHA minimum standards require one square foot of net free ventilation area for each 150 square feet of attic floor area, or one square foot per 300 square feet if a vapor barrier is installed on the warm side of the ceiling or if at least one half of the ventilation is provided near the ridge. If the ventilation openings are screened, the total area should be doubled. For further information on proper ventilation contact your architect, building contractor, building materials supplier, or TAMKO's Technical Services Department.

PROPER VENTILATION IS ESSENTIAL

Underlayment and Ice/Rain Protection Underlayment

- Products which are acceptable for use as underlayment are:
TAMKO No. 30 Asphalt Saturated Organic Felt
A non-perforated asphalt saturated organic felt which meets ASTM: D226, Type II, TAMKO TW Metal & Tile Underlayment or TW Underlayment
- The entire roof must be covered (prior to shingle application) with underlayment (double layer at eaves and valleys). This applies to new roof or re-roof applications.
- For roof slopes of 3 inches per foot to 4 inches per foot, TAMKO's self-adhering TW Metal and Tile Underlayment or TW Underlayment must be applied over the entire deck for new roof construction.
- Apply the underlayment parallel to the eaves, starting with the lowest course, lapping each course 2" (5.1cm). Where ends join, lap 4" (10.2cm).
- When covering hips and valleys, always overlap felt by extending 24" beyond the center line of the hip or valley.
- **Ice and Rain Protection:** For new construction where there is a possibility of ice forming along eaves or in valleys causing a backup of water, TAMKO TW Metal and Tile Underlayment or TW Underlayment should be used in lieu of the bottom layer of underlayment. Extend from the eave's edge to a point at least 24" (61cm) beyond the exterior wall line of the building and along the entire length of the valley, 19" (48cm) on each side of the centerline.

Traffic

- Walk only on the top portion of the shingles and avoid walking on the locks/seams.
- Wear soft-soled shoes.



APPROPRIATE FALL PROTECTION METHODS SHOULD BE USED WHENEVER WORKING ON ROOFS. Use caution, product may be slippery.

Important

Important: All detail work demands careful consideration. It is important to consider water flow and overlap materials in proper sequence!

APPLICATION INSTRUCTIONS Starter/Eave Flashing

- Cut back existing shingles flush with fascia at eaves and gables ❶. (for reroofing only).
- Apply first full width course of underlayment at eave (both new roofs and over existing shingles) and install METALWORKS Starter Flashing ❷. (Apply TW Metal and Tile Underlayment or TW Underlayment on new construction).
- Fasten Starter with 2 rows of nails/screws 18" o.c. in a staggered pattern between the two rows. ❸. Fasten through vertical face of Starter into fascia 18" o.c. ❹.
- Overlap Starter Flashing min. 2" at joints.
- Apply underlayment to entire roof (both new roofs and over existing shingles) and lap over Starter Flashing, provide second layer of underlayment at the eave ❺. (See page 1 "Underlayment and Ice/Rain Protection Underlayment")

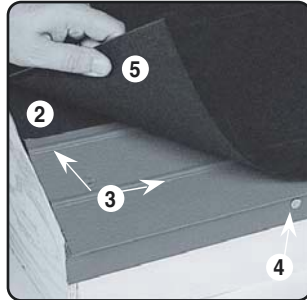

Gable/Rake Detail

- Install METALWORKS Gable flashing over underlayment at rake and over Starter at eave ❶.
- Install Gable Flashing with clips 24" o.c. Place fastener in hole near bottom of clip. Face-fasten through rake side of Gable Flashing 24" o.c. ❷.
- To join the Gable Flashings, trim the upper flashing and slide it over the lower flashing, overlapping 1-1/2 inches. The gable flashing on a dormer must be mitered to fit.

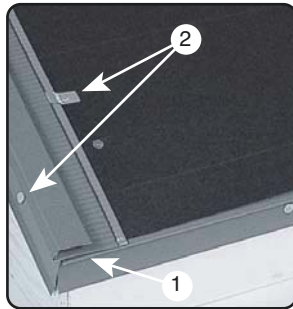

Valley Detail

- When METALWORKS Valley Flashing finishes at the eave, trim the bottom of the Valley Flashing to the correct angle and crimp over the Starter Flashing. Miter the Valley Flashing to conform to the eave line. ❶

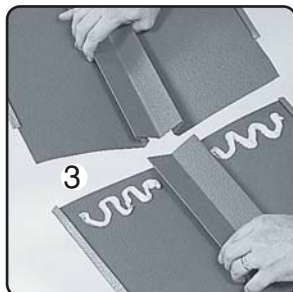
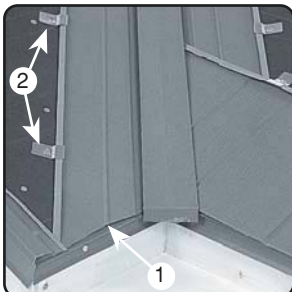

Valley Detail (continued)

- Valley Flashing with a dormer finishes over the last course of shingles below the dormer's eave.
- Place clip on one side of the valley flashing and fasten. Next, apply pressure to the valley flashing, place clip the opposite side, and fasten to assure the Valley Flashing is seated. Do not fasten through the Valley Flashing.
- Install the Valley Flashing with clips 18 inches on-center ❷.
- To join two Valley Flashings, ❸ slide the upper flashing over the lower flashing, overlapping 2 inches. Apply one-part urethane contractor-grade sealant at all joints.
- When two Valley Flashings meet at a ridge, miter the flashings to be flush at the ridge, where the the two flashings join, overlay with Hip and Ridge Seal.

Installing Shingles

- Start shingle installation at bottom left corner of roof field with a full shingle ❶. For this first shingle, cut a 2-inch notch in the return of the bottom locking lip for water to drain freely ❷.
- Lock first course to Starter Flashing and fasten with Clips (min. 3 per shingle) ❸. Place fastener in hole near bottom of clip.
- Lock second shingle and each subsequent shingle locking the left side first, then pushing the panel up to engage the bottom lock. (Note: ensure bottom lock is fully engaged).
- At the end of a row, as you approach a valley, sidewall or gable flashing, cut the right side of the shingle off to fit in the remaining space, sliding the shingle inside the corresponding flashing.
- Cut 2" notch in the return of the bottom locking lip (butt edge of shingle) in line with gables or sidewalls to allow water to drain freely (first course only) ❹.
- The numbers 2, 3 and 4 are embossed on the top lock. To start second course cut the shingle at number 2, for third course cut at number 3, then fourth course cut at number 4. To begin the fifth course of shingles start with a full shingle and continue up the rake using the same formula.

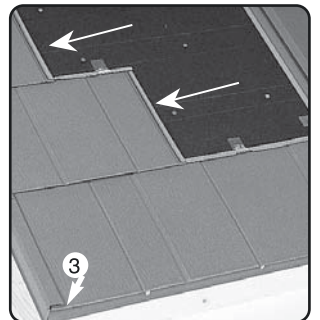
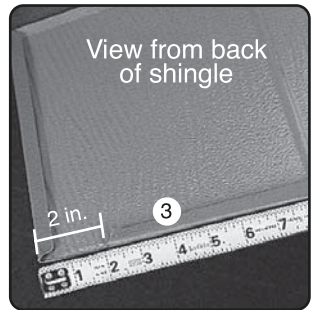
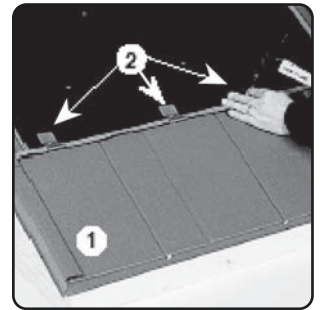

Installing Shingles (continued)

- When coming out of a valley, vary the shingle length to ensure staggered appearance. Cut the shingles to fit to the valley angle ④. The first shingle is a full length shingle. The remaining shingles and courses coming out of the valley are cut so the shingle side locks are staggered up the roof. As each course is calculated, remember to take into account the amount of shingle that is hidden in the receiver on the Valley Flashing.
- For the first course of shingles into or out of a valley, cut a 6-inch notch in the return of the bottom locking lip of the first shingle only ⑤. In all remaining valley shingles, cut a 1/2 inch V-shape notch in the return of the bottom locking lip approximately 6 inches from the center of the valley for drainage. ⑥
- At ridges and hips, line the cut edge of shingles up against one another and fasten through shingles with at least two fasteners per shingle.

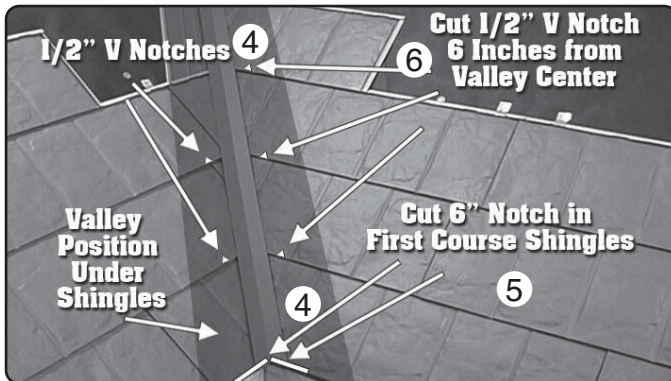

Hip and Ridge Caps

- Apply double sided Hip & Ridge Seal ① centered over the point where the shingles come together.
- Install Tapered Hip Caps or 12" Ridge Caps over Hip & Ridge Seal. Tapered Hip Caps fasten with Clips ②. Please note: METALWORKS 12" Ridge Caps with a built-in nailing hem do not require clips.
- Face-fasten the first and last cap of each section. Fasten through the cap on all four corners using nails or screws. Apply sealant over exposed fasteners.
- At the junction of two Valley Flashings, install 12" Ridge Caps to hide the sealed joint.
- Alternate method for extreme wind areas: Tapered Hip Caps may be face-fastened. Fasten through the cap on all four corners using nails or screws. If using nails, apply sealant over exposed fasteners.
- In ridge vent application, install the ridge vent over the shingles apply double sided Hip & Ridge Seal to the ridge vent then install 12" Ridge Caps over the vent ③. Depending on the type of vent used, Hip & Ridge Seal may not be applicable.
- 12" Ridge Caps can be used on the Hip or Ridge. Hip Caps should be used only on the Hip of the roof.

Note: Ensure that fasteners penetrate the roof deck min. 1/2".

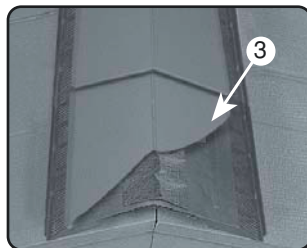
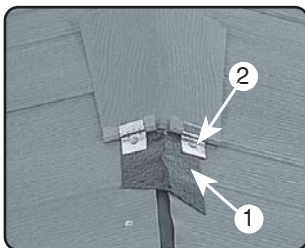

Pipe/Vent Detail

- Cut the shingle(s) to fit tightly around the pipe/vent, apply one-part urethane contractor-grade sealant around penetration ①.
- Cut and fold back the top lock of the shingle that the pipe or vent flashing will cover ②.

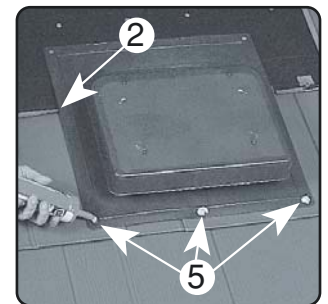
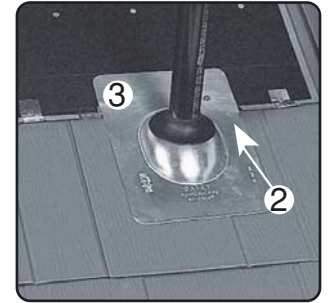
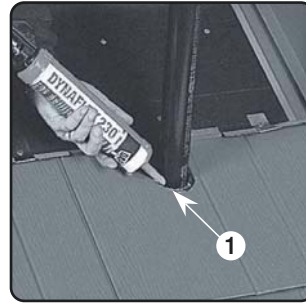

- Apply sealant to the underside of the flashing ③. Install so that the next full shingle will lap over the flashing. Apply sealant at the bottom of the shingle where it meets the top of the pipe/vent ④. Apply sealant over exposed fasteners ⑤.

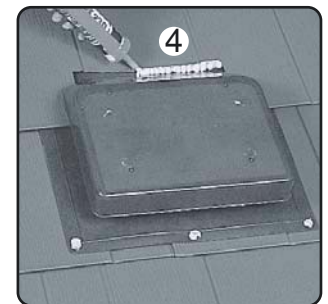

Headwall Detail

- When working around dormers, apply TAMKO's TW Moisture Wrap tape, with a minimum width of 6 inches, to the headwall area first and then to the sidewalls, wrapping the lower end back on top of the headwall. Apply sealant on top of the TW Moisture Wrap at the two front corners of the dormer.
- Cut shingles to fit below the dormer and fasten through the top of the shingle ①. Along the bottom corner of the dormer, cut the top lock of the shingle so that the sidewall flashing will lie flat over the shingle ②.
- Headwall Flashing should be formed from METALWORKS Trim Coil ③. The flashing strip should be bent to extend a minimum of 3-1/2 inches up the vertical wall and overlap the last course of shingles by a minimum of 3-1/2 inches ④.

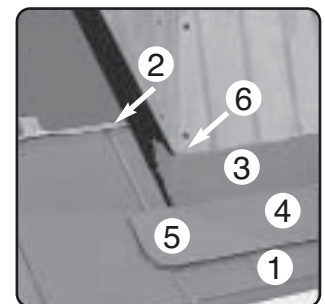

Headwall Detail (continued)

- Trim the headwall flashing so there are rounded corners that overlap the shingle. ⑤ Cut the flashing in order to wrap the vertical wall around to the sidewall ⑥.
- The Headwall Flashing should be fastened against the headwall using nails or screws every 18 inches on-center. Install Headwall Flashing under the wall covering or existing flashings.

Sidewall Detail

- Install METALWORKS Sidewall Flashing under wall covering (siding, stucco) or existing flashing wherever possible.
- When necessary cut a slot in the wall in order to properly counter-flash Sidewall Flashing.
- Ensure Sidewall Flashing overlaps on top of the course of shingles immediately below the dormer or on top of the starter strip at the eave ①.
- To join Sidewall Flashing, trim lower flashing and slide together with a 2 inch overlap.
- At a dormer, Sidewall Flashing is cut ② and crimped ③ under and at an angle to be flush with the front dormer wall.
- The bottom of the sidewall lock area that is exposed on top of the shingle should be cut and folded under.
- Apply additional sealant at the junction of the headwall and sidewall before fastening the Sidewall Flashing.
- Fasten the Sidewall Flashing to the dormer wall 18 inches on-center.
- Install the Sidewall Flashing to the roof deck with clips 24 inches on-center ④. Install the remaining shingles around the dormer.

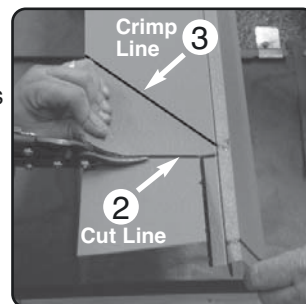
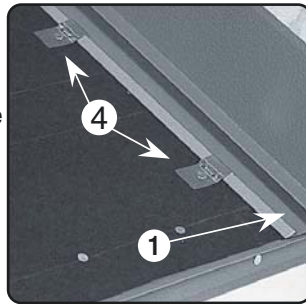

Pitch Transition Detail

- Pitch transitions must be addressed with METALWORKS specialty materials such as Trim Coil or Starter Flashing. **Do not simply bend the shingles.**
- Install TAMKO's TW Metal and Tile Underlayment or TW Underlayment on top of the last course of shingles under the transition flashing.
- Complete lower roof and install transition flashing using METALWORKS Trim Coil over last course of shingles ①. Bend Trim Coil as if forming headwall flashing, and attach above the transition area using nails or screws 18" o.c. ②. Flashing should overlap last course of shingles minimum 3-1/2 inches. Also lap underlayment over the top portion of the transition flashing. (not shown)
- Install METALWORKS Starter Flashing over transition flashing ③. Bend the Starter Flashing's edge to lay flat and create lock for next course of shingles. Fasten Starter Flashing 18" o.c. two rows in staggered pattern.
- The first course of shingles above the transition locks to the new starter installed over the transition flashing ④.

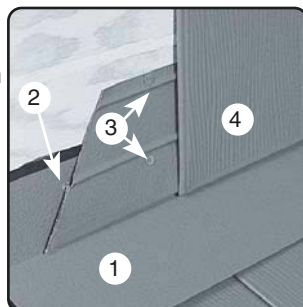

Pitch Transition Detail (continued)

- For a gambrel transition, install METALWORKS Starter Flashing at the transition point. Refer to page 2, "Starter Eave/Flashing" section.

Chimney/Skylight Detail

- Cut the last course of shingles below the chimney or skylight as close as possible to the chimney/skylight ①.
- Install headwall flashing to the bottom of the chimney/skylight using METALWORKS Trim Coil ②. (refer to Headwall Detail Section)
- Install Sidewall Flashing to the sides and extend over the last course of shingles below chimney/skylight ③ and over headwall flashing ④. (refer to Sidewall Detail Section)
- Finish shingles around chimney/skylight ⑤.

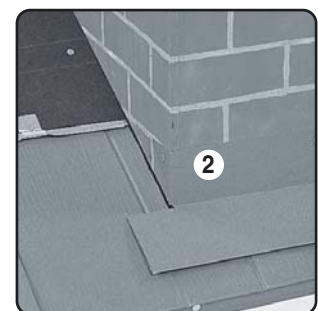
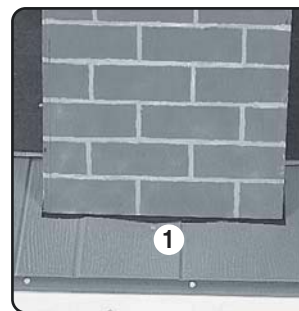

- Cut and fold back top lock of shingles(s) directly above the chimney/skylight and install a pan flashing ⑥ using METALWORKS Trim Coil so that the next course of shingles will lap over the flashing.
- Counter-flash and apply sealant as necessary.
- Large chimneys on steep roofs may require a cricket or saddle.

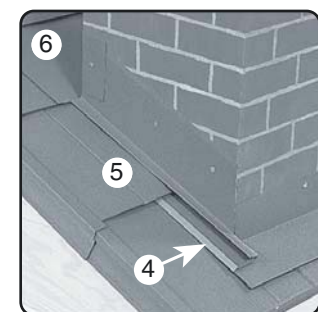
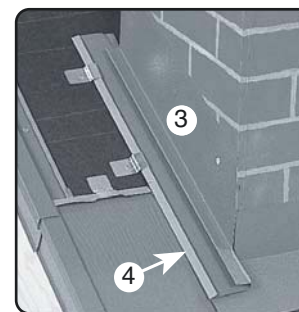

Roof Jacks

- Place protective padding (i.e. carpet, foam insulation) under roof jack to prevent damage to the shingle on which it rests ①.
- Cut and fold back the top lock of shingle to allow for roof jack insertion ②.
- Place roof jack on shingle and nail through slot in roof jack above shingle ③.
- Notch and open bottom lock on shingle directly above roof jack and install the shingle over the jack.
- After roof jack has been removed, fold opened section of bottom lock back into place and apply sealant.

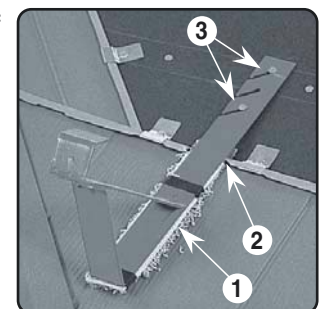

Important: All detail work demands careful consideration. It is important to consider water flow and overlap materials in proper sequence!

J-Channel

- When applying METALWORKS shingles on a vertical wall application as a siding, use J-Channel around windows, doors and other openings.

Snow Guards

- **The use of snow guards should be considered in areas where snow and ice accumulate.**
- When installing a snow guard, follow the snow guard manufacturer's recommendations for installation and placement. Installation instructions are included in the box.
- To begin, cut and fold back the top lock of shingle directly above the location of the snow guard, just as with a roof jack installation.
- Fasten above the shingle, leaving approximately two inches of the snow guard strap exposed.
- To retrofit a snow guard on an existing roof, slide the top of the snow guard under the top lock of the shingle, fasten through the shingle, apply sealant to the fasteners, and slide the sleeve over the fastener heads and under the edge of the shingle above.

Touch Up Paint

- **IMPORTANT:** This product is intended for field touch-up for **minor scratches** on METALWORKS painted product. METALWORKS product with major damage should be replaced.
- **SURFACE PREPARATION:** Prior to touch-up painting, foreign substances should be removed from the minor damage area.
- **APPLICATION:** Shake the bottle vigorously for 2 minutes. Apply one coat of METALWORKS Touch-Up Paint to the damaged area(s) only. A small brush is included inside the bottle to apply touch-up. Apply one coat of METALWORKS Touch-Up Paint to the minor damaged area only. The touch-up paint is supplied "ready to apply" and dries to a tack-free state in 15 min. at 70° Fahrenheit.
- **Use only paint supplied by TAMKO METALWORKS.**
- No spray paint of any kind should be sprayed or over sprayed on TAMKO METALWORKS products.



Removal & Replacement of Existing Shingle

- When removing a damaged shingle in the field area, it is advisable to cover the surrounding shingles to prevent possible damage to the finish.
- Slide siding zip tool under the locks and work open.
- Remove clips from the shingle and remove damaged shingle.
- Install new shingle, slide into locks and fasten with new clips.
- Reset remaining shingles and close locks.

UL Class A Fire Rated Roof

- For roof applications requiring Underwriters Laboratories, Class A fire rated roof, the entire roof area must be covered with 1/4" (6cm) DensDeck®, 1/2" gypsum board, or VersaShield® (one or two layers, depending on local building codes). One of the products listed above must be applied directly over the sheathing or existing roof, underneath the underlayment, and must be fastened in accordance with the manufacturer's specifications. One layer of appropriate underlayment shall be applied over the selected product listed above prior to installing shingles.
- Reroofing-suitable for installation over existing Class A asphalt fiberglass shingles with a minimum 15/32" (1.2cm) thick plywood decking.
- Contact TAMKO or Underwriters Laboratories for specific application requirements for UL Class A rated systems.

UL Class C Fire Rated Roof

- Minimum 15/32" sheathing and one layer of appropriate underlayment shall be used in roof applications requiring Underwriters Laboratories, Inc. Class C fire rated roof.

Reroofing

- Can be installed over up to two layers of asphalt shingles.
- Check your Local Building Code. Building Code restrictions may apply.

Disclaimer: It is the responsibility of the installer to ensure installation is completed according to directions, and that all construction by-laws and codes are met. TAMKO is not responsible for damage of any kind resulting from faulty or improper installation.

tamko.com
metalworksroof.com

Shingles

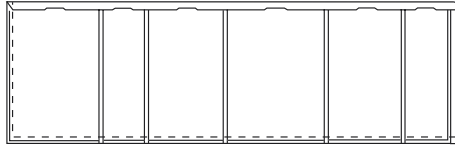

AstonWood Shingles
30 pc/ctn. - 98.5 sf/ctn.
61 lbs/sq. (packaged wt. 70 lbs/ctn.)
18 sq./single pallet

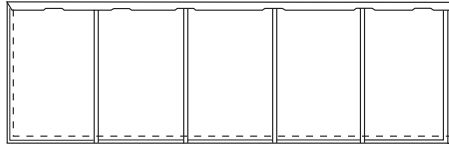

StoneCrest Slate Shingles
15 pc/ctn. - 49.25 sf/ctn.
74 lbs/sq. (packaged wt. 43 lbs/ctn.)
12 sq./single pallet

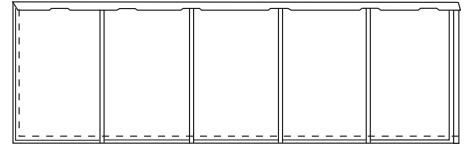

StoneCrest Tile Shingles
15 pc/ctn. - 49.25 sf/ctn.
74 lbs/sq. (packaged wt. 43 lbs/ctn.)
12 sq./single pallet

Metal Accessories

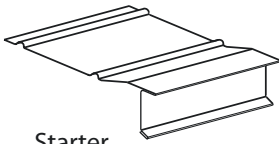

Starter
10 pc/ctn. - 100 lf/ctn.
35 lbs/ctn.
30 ctn./pallet

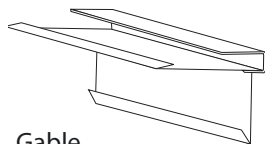

Gable
10 pc/ctn. - 100 lf/ctn.
41 lbs/ctn.
24 ctn./pallet

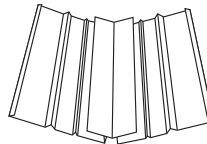

Valley
5 pc/ctn. - 50 lf/ctn.
56 lbs/ctn.
12 ctn./pallet

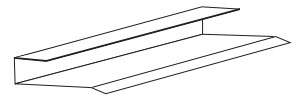

J-Channel
10 pc/ctn. - 100 lf/ctn.
17 lbs/ctn.
30 ctn./pallet

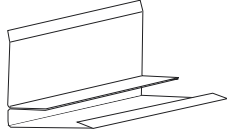

Sidewall
5 pc/ctn. - 50 lf/ctn.
25 lbs/ctn.
30 ctn./pallet

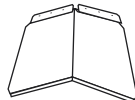

12" Ridge Cap
25 pc/ctn. - 25 lf/ctn.
19 lbs/ctn.
45 ctn./pallet

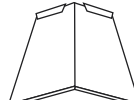

Hip Cap Tapered
StoneCrest or AstonWood
50 pc/ctn. - 50 lf/ctn.
21 lbs/ctn.
32 ctn./pallet



Trim Coil
22-1/4" x 50'
1 pc/ctn.
47 lbs/ctn.
30 ctn./pallet

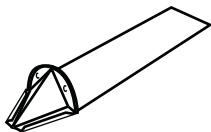

Snow Guard
100 pc/ctn.
16 lbs/ctn.
30 ctn./pallet



Clips
400 pc/ctn. - 100+/- pc/sq.
8 lbs/ctn.
90 ctn./pallet

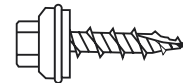

Colored Screws
50 pc/bag
0.5 lbs/bag

Non-Metal Accessories



Hip & Ridge Seal
4" x 50'
1 pc/ctn.
6 lbs/ctn.

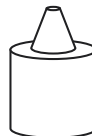

Touch Up Paint
2 oz/btl.
12 btl/ctn.
2.2 lbs/ctn.

TAMKO® is a US and Canadian registered trademark of TAMKO Building Products, Inc.
TAMKO® in a box logo is a US registered trademark of TAMKO Building Products, Inc.
TAMKO® in a box logo is a Canadian trademark of TAMKO Building Products, Inc.
METALWORKS™ and Metalworks and Design™ are US registered trademarks of TAMKO Building Products, Inc.
METALWORKS™ is a Canadian trademark of TAMKO Building Products, Inc.
AstonWood® and StoneCrest® are US registered trademarks of TAMKO Building Products, Inc.
DensDeck® is a US and Canadian registered trademark of Georgia-Pacific Corporation.
VeraShield® is a US registered trademark of Elk Premium Building Products, Inc.